

# EXPLODED DRAWING A—Model No. F612.0

R0909A

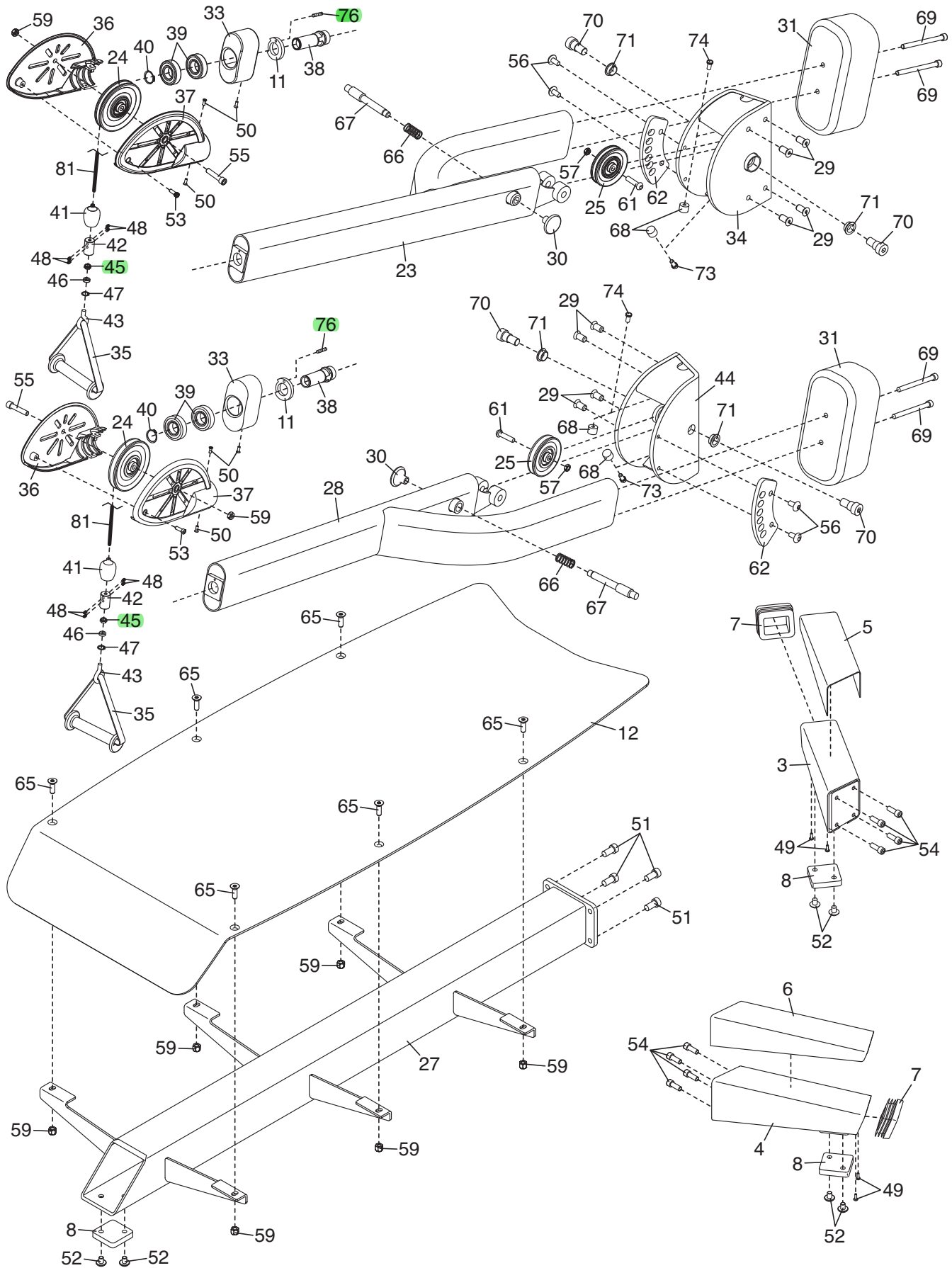

# EXPLODED DRAWING B—Model No. F612.0

R0909A

